



For The ON-THE-GO Pet™

INSTRUCTION MANUAL SPECIAL EDITION NO-ZIP PET STROLLER

PG8250NZ



To see our full line of products, visit us online at: www.petgearinc.com

CUSTOMER SERVICE HELP DESK

customerservice@petgearinc.com

Toll-Free 877-752-9123 - Eastern Standard Time 8am-3pm, Monday through Friday

PARTS LIST

Check that you have all the parts shown BEFORE assembling your product.
If any parts are missing, call Customer Service.

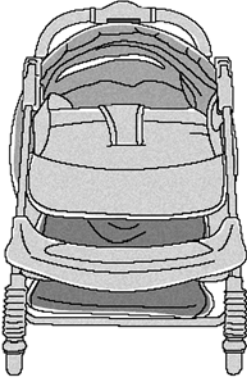

Stroller

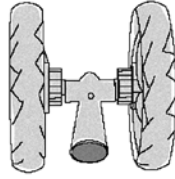

2-Front Wheel Assembly

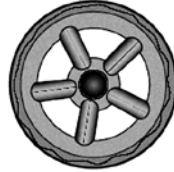

2-Rear Wheels



Rear Axle Assembly



Back Tray



2-Washers



2-Cotter Pins



2-Hub Caps

UNFOLDING THE STROLLER

Step 1. Release folding latch (A).

Step 2. Spread handle (B) and seat apart until the frame clicks and locks on both sides.

Step 3. Ensure that the stroller is locked in on both sides before using.

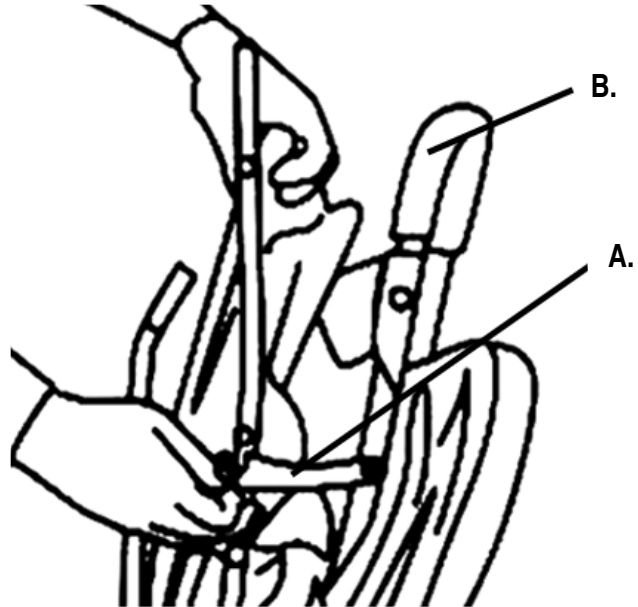

OPENING THE STROLLER

Spread the canopy apart to the open position.

Canopy



TO ASSEMBLE REAR WHEELS

Step 1. Slide wheel assembly onto axle.

Step 2. Slide washer onto axle.

Step 3. Fit straight part of cotter pin through hole on axle.

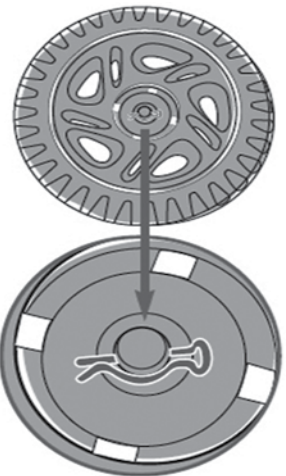
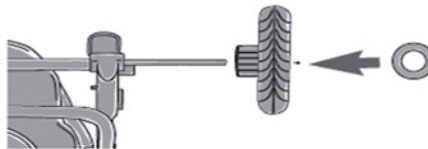

Step 4. Line up each of the tabs in the hub cap with the slots in the wheel, snap hub cap into place.

Step 5. Repeat for other side.



TO ASSEMBLE REAR AXLE TO FRAME

Step 1. Turn stroller over.

Step 2. Position rear axle assembly as shown.

Step 3. Push rear axle onto frame until it clicks and locks into place on both sides.

NOTE: Pull down firmly on the brackets to be sure they are securely attached to the stroller's rear legs.

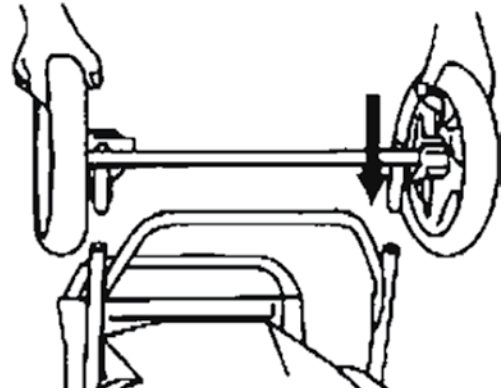

TO ASSEMBLE FRONT WHEELS

Step 1. Place front wheels unit on leg with locking lever pointing downward.

Step 2. Press locking lever and slide swivel housing onto front leg.

Step 3. Release locking lever.

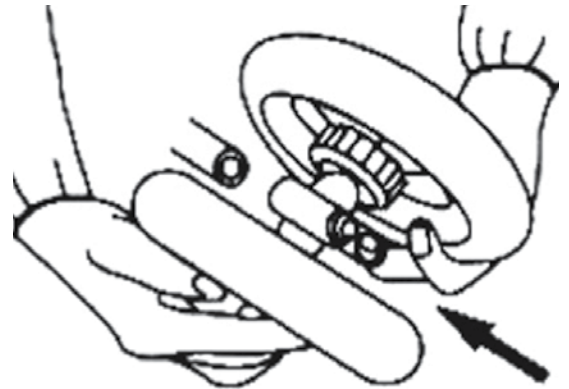

APPLYING THE BRAKES

Step 1. Push levers on both rear wheels down to lock.

Step 2. Pull levers up to unlock.

WARNING: Never leave your stroller parked without applying brakes.



TO SECURE COMPARTMENT TO FRAME



Step 1. Open stroller and pull compartment down.



Step 2. Clip onto frame.

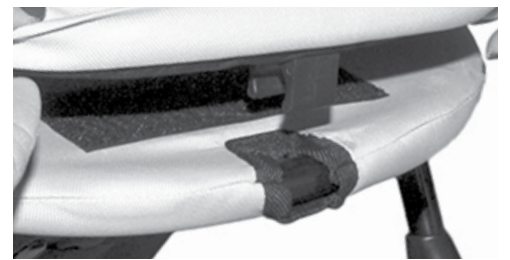

TO SECURE LATCH

Step 1. To close compartment, pull downward to latch clip onto frame.

Step 2. Lift up on latch clip and secure by pushing down until it locks.



TO UNLOCK LATCH

Pull upward on latch clip to release.



TO SECURE SIDE FLAP

To help secure compartment, Velcro flaps around tube and fasten to the bottom of the compartment.



TO USE FRONT WHEEL LOCKING MECHANISM

Step 1. To engage the front wheel locking mechanism so that the front wheel does not swivel, (best when the stroller is used for fast walking or running), pull tab up.

Step 2. To disengage the locking mechanism so that the front wheel swivels (for easy steering) push tab down.

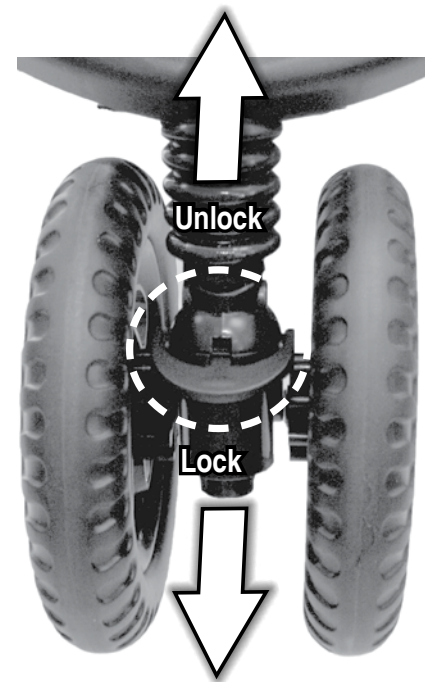

TO ASSEMBLE BACK TRAY

Step 1. To assemble the back tray, first align a hole on one side of the tray with one of the bolts on the handle of the same side of the stroller.

Step 2. Snap one side of the tray over the bolt on the handle then repeat for the other side.



FOLDING THE STROLLER

Step 1. For ease in folding the stroller, unlock latch, open the canopy, and unwrap the Velcro flaps from around tube on both sides of the stroller.



Unlock latch.



Open the canopy.



Flaps need to be unwrapped on both sides of the stroller.



Unwrap the Velcro flaps from around tube.



Step 3. Pull upward on the compartment. At this point, please make sure that latch is unlocked, the canopy is open, and the 2 Velcro flaps from around tubes on both sides of the stroller are unwrapped.

FOLDING THE STROLLER

Step 4. Slide frame lock release (C) to the right, while squeezing the main frame lock release (D) rotate the folding mechanism almost 180 degrees forward until stroller releases and handle is lowered.

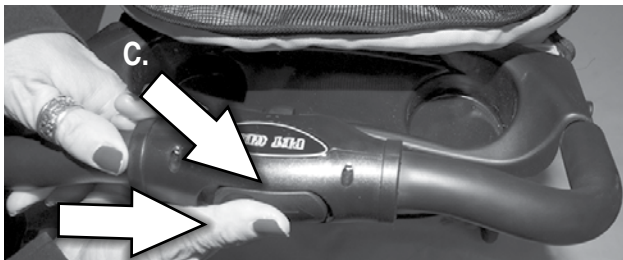
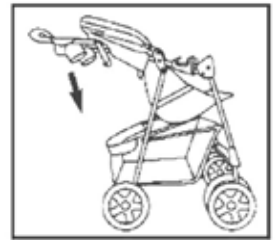
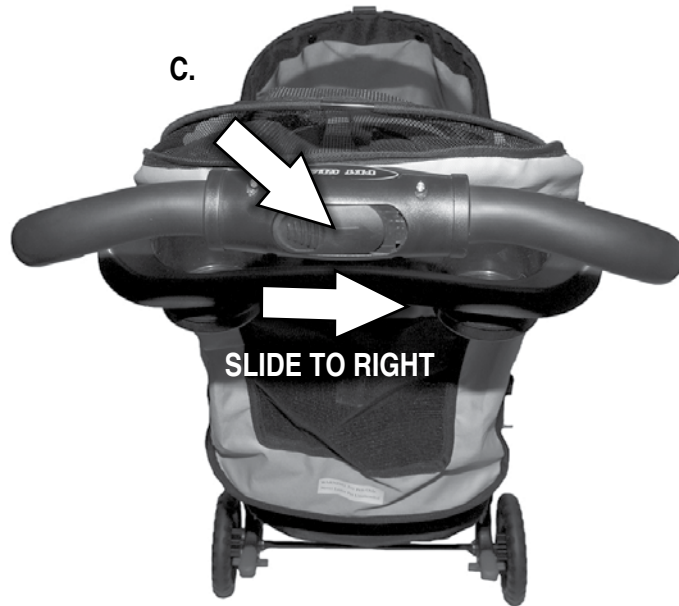

TO REMOVE FRONT WHEELS

To remove front wheels, squeeze tabs and pull off wheel assembly.

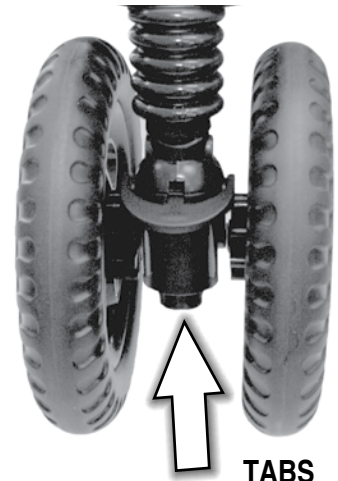
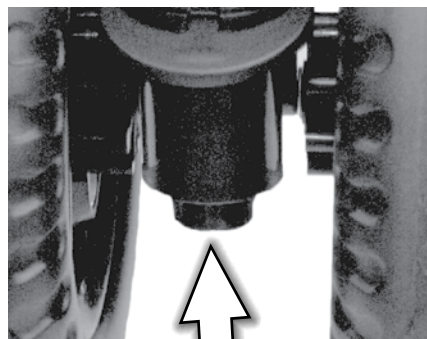

LOOKING AFTER YOUR STROLLER

- Always store product in a clean, dry place.
- Not recommended for use on the beach.
- Do not put heavy items on top of the stroller.
- Clean frame by wiping with a lightly oiled cloth.
- Do not use detergent or abrasives. Spot clean fabric with dry cleaning fluid or mild soap and warm water.
- To ensure easy maneuverability and to minimize wear and tear, (especially wheels, axles, and swivels), keep all moving parts clean and lubricated with WD40® or light machine oil.
- NOTE: Do not lubricate brake components or swivel locks.
- Regularly check stroller for loose parts. These should be tightened or replaced.

WHEEL MAINTENANCE

- To clean and lubricate front and rear wheels, push out locking lever under wheel housing to release rear wheel.
- To ensure ease of maneuverability and to minimize wear and tear, keep all moving parts clean and lubricated with WD40® or light machine oil.
- Push wheel sets back on until they click and lock in position; pull on wheel housings to ensure they are secure.
- Push stroller back and forth and rotate swivels around to work in lubricant.
- Clean the rear wheel assembly and the rest of the frame with warm, soapy water; clean off with warm water and dry thoroughly.
- NOTE: Do not lubricate brake components or swivel locks.

⚠ WARNING!

FOR PETS ONLY.

Not intended to be used as a restraining device for aggressive or dangerous animals that dig, chew or paw aggressively. Do not leave your pet unattended. **PET GEAR** is not liable for any damage caused by aggressive, destructive, immature or untrained animals. Do not use near an open or exposed flame. Failure to follow these warnings and the instructions could result in serious injury or death.

- Do not carry additional bags, goods, or accessories in or on stroller except as recommended in the manufacturer's instructions.
- Recommended use of an approved safety restraint correctly fitted and adjusted.
- Do not leave pet unsupervised in stroller.
- Before making adjustments to stroller ensure that pet's body is clear of any moving parts.
- This stroller is designed for one pet only.
- Do not hang bags from handles as this may cause the product to become unstable.
- Do not use on escalator or stairs; fold stroller and carry.
- Put on brake whenever you park the stroller.
- Ensure stroller is completely erected and check that all locks are engaged before placing pet in stroller.
- Do not overload as stroller may become unstable; maximum weight of pet using this stroller not to exceed 45 lbs.
- Any goods carried in the basket not to exceed 6 lbs.

REPLACEMENT PARTS

Use only **PET GEAR** replacement parts.

Please have your model number ready before calling.

You can also request parts: <http://www.petgearinc.com/main.asp?sel=2>



192 Sheldon Avenue • West Rutland, VT 05777 • 877-752-9123 • www.petgearinc.com